



PAST PAPERS

Faculty Not Applicable	Department / Section/Division Learning Resource Centre
---------------------------	---

Past Papers

Faculty of Management, Humanities & social
Sciences
Department of Education & Language

**BSc. (Hons) Bachelor of Art (English) Degree
(Year 3 – Semester II)
2022**

Document Control & Approving Authority	Senior Director – Quality Management & Administration		
Issue Date: 2017.011.30	Revision No.00	Revision Date: 12/01/ 2022	Validated by: Librarian

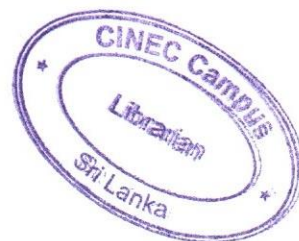

FINAL EXAMINATION QUESTION PAPER

CODE - QP

Approved for Quality Management System

EDUCATION & TRAINING COURSE: BACHELOR OF ARTS IN ENGLISH

COURSE CODE: LC - 0845

SUBJECT: TESTING AND EVALUATION (TESL 3201)

Faculty	Department / Section / Division
Humanities and Education	English

INSTRUCTIONS TO CANDIDATES	2021.11.10
<i>There are eight (08) questions in this paper. Answer any four (04) questions</i>	Duration of the examination = 03 hours
<i>Each question carries 15 marks.</i>	Candidates could be disqualified if you violate examination rules
<i>Read the questions carefully and answer to the point. Write what you are asked to write and not what you want to write.</i>	Candidates are not allowed to communicate with and disturb fellow candidates during the examination.
<i>Marks will be deducted for spelling and grammatical errors.</i>	

- ❖ Answer any **four (04)** questions
- ❖ Each question carries **15 marks.**
- ❖ **Read the questions carefully and answer to the point. Write what you are asked to write and not what you want to write.**
- ❖ Marks will be deducted for spelling and grammatical errors.

QUESTION 01

- A. Achieving a beneficial back wash should be an important aim of an Achievement Test.
Discuss. **(09 marks)**
- B. Given below are three test items from the G.C.E. O/L test paper. Analyze these items in terms of skill or language area tested, aim, validity and scorer reliability. **(06 marks)**

i) **Complete the following sentences by putting the words in brackets in the correct order. (05 marks)**

1. Water
(in/cheapest/ is/ the/ world/ the/ drink)
2. The Minister
(holiday/ next/ declared/ day/ a/the)
3. An accountant.....
(who knows/ the value/ is/ of/ someone/ the cost/ nothing/ everything/and/of)
4. Electronic mail
(by /was started/ in / the armed forces/the United States of America/ called e-mail/
the late 1960's/ of)
5. We are
(irresponsible behaviour/ but/ are backing/ sick/ their/of/the media/ them)

ii) **Your house is located at 23, Shrama Shakthi Mawatha, Kosgama, Rathnapura. When you get home from school, you discover that your house has been burgled. You telephone the nearest police station. Use the given guidelines and complete the dialogue between you and the police officer. (05 marks)**

Police officer: Rathnapura Police Station. Can I help you?

You :
(Inform what has happened.)

Police:
(Inquires about the location of your house.)

You:
(Give relevant information.)

Police:
(Inquires about the time of the incident.)

You:
(Give relevant information.)

Police: Was anything stolen?

You: Yes. All our jewellery's gone, and my computer too.

Police: Right. Our officers will be round in fifteen minutes. Please don't touch anything.

iii) Write a paragraph beginning with the following sentence. (05 marks)

“That was the worst accident I had ever seen”

Use about 75 – 100 words. Do not exceed this word limit.

Writing descriptor

	Description	Mark Bands
Content & organization	Content interesting and relevant to the given topic sentence. Sentences are in a logical sequence. Has used specified word length. Has produced a good paragraph.	0 - 2
Language Use	Has used grammatically correct sentences and appropriate vocabulary. No spelling or punctuation errors.	0 - 3

QUESTION 02

Write short notes on **three** (03) of the following:

(3X5 =15 marks)

- a) Discrimination
- b) Reliability
- c) Selection Test
- d) Direct Test and Indirect Test
- e) Norm-referenced Test and Criterion-referenced Test
- f) Assessment for Learning (Formative Assessment)

QUESTION 03

Self-assessment can be a good indicator for an important learning activity and is able to deliver incredible feedback to the learners regarding their learning”. (Falchikov and Boud - 1989) Do you agree? Give your reasons.

QUESTION 04

A. Why is Speaking the most difficult skill to test?

(09 marks)

B. Describe three tests of Speaking – one individual test, one pair test and one group test. You should state the aim(s) and techniques of these tests.

(06 marks)

QUESTION 05

A. What aspects of vocabulary should be focused on when testing Vocabulary?
 Illustrate with suitable examples. **(09 marks)**

B. Comment on the following test items with reference to their aim and scorer reliability.
(06 marks)

Item I

Underline the most appropriate word from those given in brackets.

(05 marks)

- i) *I am doing well in life now because my parents and teachers (told, advised, gave) me proper guidance.*
- ii) *He (treated, did, considered) animals cruelly.*
- iii) *The chairman (finished, adjourned, completed) the meeting at five.*
- iv) *My uncle is (beautiful, pretty, handsome). Many women admire him.*
- v) *I feel very sorry for his pathetic (site, plight, placement). I wonder how he will come out of it.*

Item II

Underline the correct word ending selecting from those given in brackets.

(05 marks)

- 1. *A new treat..... (ed, ing, ment) is being tried for cancer.*
- 2. *Immediate help was sent to the surviv (ors, al, ing) of the plane crash.*
- 3. *We can stop a train in an emerg (ent, ency, ging) by pulling the communication cord.*
- 4. *He told me that he had met his aunt the prev..... (ious, iously, iew) week.*
- 5. *The match was very excit..... (ement, ed, ing) towards the end.*

Item III

Read the following text and give the meaning of the words in bold print as they appear in the text.

(10 marks)

*The "Aeneid" is a legendary (1) **narrative** about the imagined (2) **origin** of the Roman nation.*

*It is an epic poem. An epic is a long narrative poem, full of action, which tells about human life and makes us (3) **wonder** about the relationship between man and the gods. The main characters in epics are heroes. Very often, epics show (4) **clashes** between heroes and gods.*

*The "Aeneid" tells of the Trojan prince who was said to have (5) **escaped** during the sack of Troy and sailed, with other Trojans, to the west coast of Italy where they (6) **founded** early Rome. The epic describes the many (7) **trials** they had to face before they finally arrived at their (8) **destiny**. This story is (9) **significant** for the role the gods take in men's (10) **affair**.*

QUESTION 06

Write an essay on Cloze Test with reference to the sample cloze test given below (*refer page 6*).

You should include the following points in your answer:

- 1) What a Cloze Test is.
- 2) How it is constructed.
- 3) Deletion rate.
- 4) Aims of the Cloze Test

Sample Cloze Test

In the following text some of the words have been left out. First read the whole passage and try to understand what it is about. Then, try to fill in the blanks. Each word should be filled with only one word. Contractions like 'can't' or words written with a hyphen like well-being are counted as single words. If you are not sure of the word that has been left out, guess.

It was a sports stadium. Eight children were standing on the track to participate in a running event.

** Ready! * Steady! * Bang !!! With the sound of Toy pistol, (1) eight girls started running. (2)had they covered fifteen (3) when one of the (4)..... girls slipped and fell (5) Due to bruise and (6) she started crying. When (7) other seven girls heard (8) little girl cry, they (9) running, stood for a (10)..... and turned back. Seeing (11) girl on the track (12) all ran to help (13) One among them bent (14), and kissed her gently (15) enquired as to how (16) was. They gently lifted (17) little girl and kissed (18) Two of them lifted (19) firmly while all seven (20)..... hands together and walked together towards the winning post.*

There was pin drop silence at the spectator's stand. Officials were shocked. Slow claps multiplied to thousands as the spectators stood up in appreciation. Many eyes were filled with tears.

QUESTION 07

You have been asked to conduct a seminar to a group of teachers on "How to construct a good English Language Test". Write the guidelines you will give them.

QUESTION 08

"Achieving scorer reliability in a literature test is a difficult task since test the items are subjective rather than objective." Discuss in detail how this issue could be overcome.

.....END OF THE QUESTION PAPER.....

Library

00015



END SEMESTER EXAMINATION QUESTION PAPER

CODE - QP

Approved for Quality Management System

EDUCATION & TRAINING COURSE: BACHELOR OF ARTS (ENGLISH) DEGREE

COURSE CODE: LC - 0845

YEAR III - SEMESTER II

WORLD LITERATURE IN TRANSLATION- ELIT 3201

Faculty	Department / Section/Division
Humanities and Education	English

INSTRUCTIONS TO CANDIDATES	Date of the examination: 2021.11.08
This paper has four (4) sections and seven (07) questions.	Duration of the examination = 03 hours
Answer four (04) questions Answer three (03) questions selecting one from Sections A, B and C. Section D is compulsory.	Total Marks = 60
Each question carries fifteen (15) marks.	
Candidates could be disqualified if you violate examination rules.	
Candidates are not allowed to communicate with and disturb fellow candidates during the examination.	

- ❖ Answer four (04) questions
- ❖ Answer three (3) questions selecting one (1) from sections A, B, & C.
- ❖ Section D is compulsory.
- ❖ Each question carries fifteen (15) marks.

SECTION A

QUESTION 1

In the drama *Mother Courage and her Children*, Bertolt Brecht has portrayed more than one courageous character. To what extent do you agree with this statement? Give reasons for your answer.

QUESTION 2

In your opinion, what does Kattrin represent in *Mother Courage and her Children*? Give reasons for your answer.

SECTION B**QUESTION 3**

The Ramayana is often interpreted as a meditation upon the Hindu value of dharma. Comment.

QUESTION 4

Rama, the hero in *The Ramayana*, displays great qualities such as devotion, bravery, and honor. Critically evaluate this statement by referring to the text.

SECTION C**QUESTION 5**

Loyalty and bravery are human virtues that are important in a war context. To what extent do you agree with this statement? Substantiate your answer with quotations from *Mother Courage and her Children*.

QUESTION 6

The Ramayana by R.K Narayan is a morality tale of good versus evil. Do you agree with this statement? Substantiate your answer

SECTION D – Compulsory**QUESTION 7**

Write short notes on any three of the following.

- I. Describe briefly the evolution of Pavel's character in *Mother* from an immature boy in a poor family to a visionary leader, who became an inspiration to the proletariat movement.
- II. What aspects in the mother's character make her an accepted and a loved community front-runner? Discuss briefly with quotations.
- III. Discuss briefly *Gamperaliya* as a romantic classic that exemplifies various aspects of opposite-sex relationships.
- IV. Comment on the contribution and significance of minor characters: Tissa and Kathirina in *Gamperaliya* by Martin Wickramasinghe.

END SEMESTER EXAMINATION QUESTION PAPER

CODE - QP

Approved for Quality Management System

EDUCATION & TRAINING COURSE: BACHELOR OF ARTS IN ENGLISH

COURSE CODE: LC – 0845

SUBJECT: LANGUAGE AND SPEECH DISABILITIES – ELAN 3201

YEAR 3- SEMESTER 2

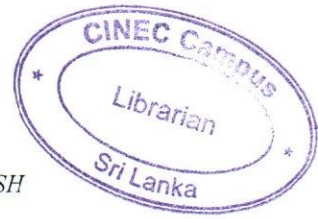

<i>INSTRUCTIONS TO CANDIDATES</i>	
<i>There are two (02) parts and eight (08) questions in this paper.</i>	<i>Duration of the examination = 03 hours</i>
<i>Answer four (04) Questions selecting (02) two from each part.</i>	<i>Date: 2021.11.12</i>
<i>Each question carries 15 marks.</i>	<i>Candidates are not allowed to communicate with and disturb fellow candidates during the examination.</i>
	<i>Candidates could be disqualified if you violate examination rules.</i>

- ❖ There are two (02) parts and eight (08) questions in this paper.
- ❖ Answer four (04) questions selecting two (02) from each part.

PART 1**QUESTION 01**

- a. Describe in detail the characteristics of Autism Spectrum Disorder (ASD). (7 marks)
- b. Select four factors that are included in a speech and language assessment of ASD, and explain each. (8 marks)

QUESTION 02

(3 X 5 =15 marks)

Write short notes on the following:

- a. Psychosocial impact of Cleft Lip and/ or Palate (CLP)
- b. Early speech and language characteristics
- c. Two roles and responsibilities of a Speech-Language Pathologist (SLP) with regard to CLP.

QUESTION 03

Write a note regarding craniosynostosis, focusing on any three points related to this topic.

QUESTION 04

Write short notes on **three** of the following:

(3 X 5 =15 marks)

- a. Five speech subsystems
- b. Augmentative and Alternative Communication (AAC)
- c. Restorative and compensatory treatment approaches
- d. Treatment strategies related to Autism Spectrum Disorder (ASD)
- e. Craniofacial anomalies (CFA)

PART 2

QUESTION 05

Describe the speech and language difficulties associated with Anomic Aphasia, Broca's Aphasia, Wernicke's Aphasia.

QUESTION 06

"Stuttering is a communication disorder characterized by involuntary disruptions in the smooth forward flow of speech" (Arenas et al., 2017).

- a) Discuss the two main types of stuttering. **(05 marks)**
- b) Describe the difference between stuttering and cluttering. **(10 marks)**

QUESTION 07

Discuss the treatment methods that are used to treat patients with traumatic brain injuries (TBI).

QUESTION 08

Describe the signs and symptoms related to motor skills, speech production and language, especially of patients with Developmental Verbal Dyspraxia (DVD) or Childhood Apraxia of Speech (CAS).

..... END OF THE QUESTION PAPER



END SEMESTER EXAMINATION QUESTION PAPER

CODE - QP

Approved for Quality Management System



EDUCATION & TRAINING COURSE: BACHELOR OF ARTS IN ENGLISH

COURSE CODE: LC – 0845

ACADEMIC WRITING – ELAN 3202

YEAR 3- SEMESTER 2

<i>INSTRUCTIONS TO CANDIDATES</i>	
<i>There are three (03) questions in this paper.</i>	<i>Duration of the examination = 03 hours</i>
<i>Answer all questions.</i>	<i>Date: 2021.11.12</i>
<i>Each question carries 20 marks.</i>	<i>Candidates are not allowed to communicate with and disturb fellow candidates during the examination.</i>
<i>Total Marks – 60%</i>	<i>Candidates could be disqualified if you violate examination rules.</i>

- ❖ **There are three (03) questions in this paper.**
- ❖ **Answer all questions.**

QUESTION 01

(20 Marks)

Write a summary of the following passage in about 75 words:

People act a little strangely when a television camera comes their way. Some people behave as if a crazy puppeteer were pulling their strings. Their arms jerk wildly about, and they begin jumping up and down for no apparent reason. Often they accompany their body movements with loud screams, squeals, and yelps. Another group of people engage in an activity known as the cover-up. They will be calmly watching a sports game or other televised event when they realize the camera is focused on them. The camera operator can't resist zooming in for a close-up of these people. Then there are those who practice their funny faces on the unsuspecting public. They take advantage of the television time to show off their talents, hoping to get that big break that will carry them to stardom. Finally, there are those who pretend they are above reacting for the camera. They wipe an expression from their faces and appear to be interested in something else. Yet if the camera stays on them long enough, they will slyly check to see if they are still being watched. Everybody's behavior seems to be slightly strange in front of a TV camera.

QUESTION 02

(10 x 2 = 20 Marks)

Paraphrase each of the following texts:

- a. If you consider a word such as *rebuild*, you will note that there are two distinct elements of meaning in it: *re* and *build* – that is ‘to build again’. The same applies to *disbelieve*, which may be paraphrased as ‘not to believe’. Elements of meaning which are represented by several orthographic words in one language, say English, may be represented by one orthographic word in another and vice versa. For instance, tennis player is written as one word in Turkish, *tenisçi*, and *if it is cheap* as one word in Japanese, *yasukattara*, but the verb *type* is rendered by three words in Spanish: *pasar a maquina*.
- b. There are two main types of training that a profession can provide for its members: vocational training and academic training. Vocational courses provide training in practical skills but do not include a strong theoretical component. A good example would be a course in plumbing or typing. At the end of a typing course, a student is able to type accurately and at speed and has a piece of paper to prove it. But that is the end of the story; what the student acquires is a purely practical skill which is recognized by society as ‘skilled work’ but is not generally elevated to the level of a profession.

QUESTION 03

(20 Marks)

Write a data commentary on the bar graph provided below. Use between 200-250 words.

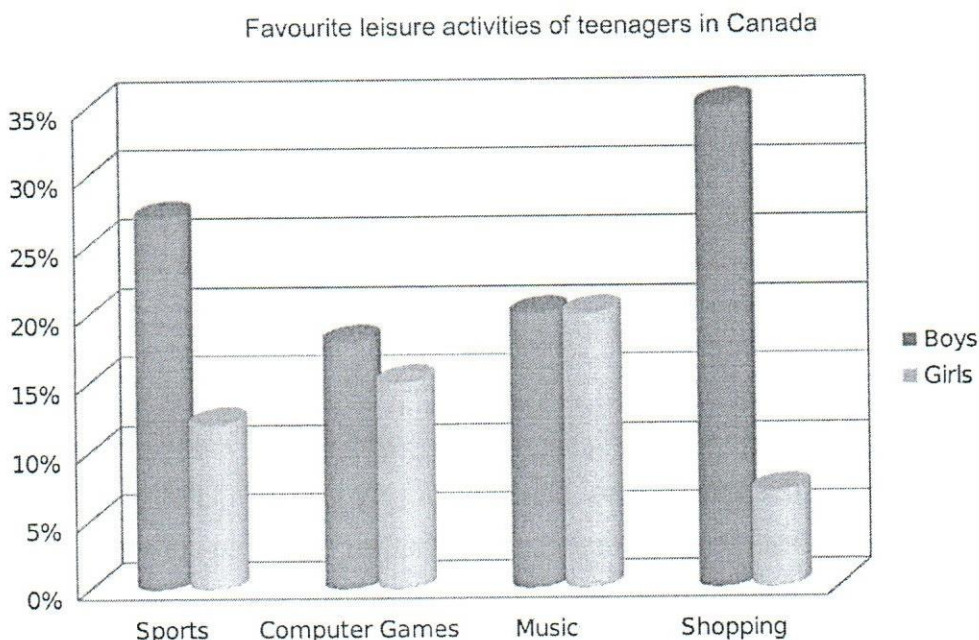

..... END OF THE QUESTION PAPER

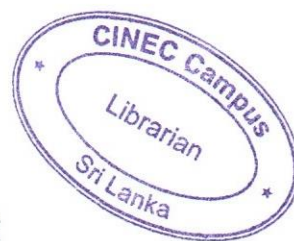
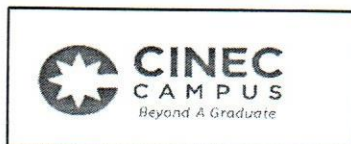

FINAL EXAMINATION QUESTION PAPER

CODE - QP

Approved for Quality Management System

EDUCATION & TRAINING COURSE: BACHELOR OF ARTS IN ENGLISH

COURSE CODE: LC - 0845

SUBJECT: PSYCHOLINGUISTICS - ELAN 3203

<i>Faculty</i>	<i>Department / Section/Division</i>
<i>Humanities and Education</i>	<i>English</i>

EDUCATION & TRAINING COURSE: BACHELOR OF ARTS (ENGLISH) DEGREE

COURSE CODE: LC - 0845

END SEMESTER EXAMINATION QUESTION PAPER

PSYCHOLINGUISTICS - ELAN 3203

YEAR 3 - SEMESTER 2

<i>INSTRUCTIONS TO CANDIDATES</i>	
<i>There are six (06) questions in this paper.</i>	<i>Duration of the examination = 03 hours</i>
<i>Candidates are required to answer any four (04) Questions.</i>	<i>Date: 2021.11.08</i>
<i>Each question carries 15 marks.</i>	<i>Candidates are not allowed to communicate with and disturb fellow candidates during the examination.</i>
	<i>Candidates could be disqualified if you violate examination rules.</i>

THERE ARE SIX (06) QUESTIONS IN THIS PAPER.

ANSWER ANY FOUR (04) QUESTIONS.

QUESTION 01

(15 marks)

Based on Grosjean (2012), discuss 03 factors given below providing examples through your experience as a bilingual.

- i. Bilingual profiles at two different stages in your life. Use a grid which illustrates language use and language fluency.
- ii. The wax and wane of languages.
- iii. Use of languages by you in different domains of life.
- iv. Language mode when you interact with others.
- v. Examples of your code-switching and borrowing when you interact with others.

QUESTION 02**(15 marks)**

Discussing neuroplasticity of the brain and second language development state whether human beings can learn languages after the critical period/puberty.

QUESTION 03**(15 marks)**

Write detailed descriptions on three 03 of the topics given below.

- i. Broca's Area
- ii. Wernicke's Area
- iii. Triune Brain of mammals
- iv. Human brain vs. chimpanzee brain
- v. Brain Lateralization

QUESTION 04**(15 marks)**

Comment on three 03 of the statements given below.

- i. Kuhl's Native Language Magnet Theory.
- ii. Infants are neither the tabula rasas that Skinner described nor the innate grammarians that Chomsky envisioned.
- iii. Discuss the experiment which proved that full term newborns have more than two months of auditory experience and can recognize familiar sounds.
- iv. Vocal imitation links speech perception to speech production.
- v. Infant-directed speech helps infants to acquire sounds used in their native language.

QUESTION 05**(15 marks)**

- i. Discuss the similarities and the differences between conscious and unconscious knowledge.
(5 marks)
- ii. Using the Global Workspace Theory describe how both conscious and unconscious processes are involved in language production.
(10 marks)

QUESTION 06**(15 marks)**

Drawing an illustration discuss brain activation during word retrieval in an English and Sinhala/Tamil bilingual child when given the following task.

'Name the animal in the picture in English.' (Avoid using *cat* as the animal.)

Include conceptual/semantic and lexical level activation, phonological encoding, inhibitory processes and syllable programming.

..... END OF THE QUESTION PAPER

libRARY ✓



CINEC Campus (Pvt) Ltd
Approved for Quality Management System

Faculty	Department / Section/Division
Management, Humanities and Social Sciences	Education and Languages

EDUCATION & TRAINING COURSE: BACHELOR OF ARTS (ENGLISH) DEGREE COURSE CODE: LC - 0845 MID SEMESTER EXAMINATION QUESTION PAPER YEAR 3 - SEMESTER II LANGUAGE AND SPEECH DISABILITIES - ELAN 3201
--

INSTRUCTIONS TO CANDIDATES	
This paper has four questions.	Duration of the examination = 1 ½ hours
Answer any three questions.	Date: 2020.01.12
Questions must be answered on the question paper itself.	Candidates are not allowed to communicate with and disturb fellow candidates during the examination.
	Candidates could be disqualified if you violate examination rules.

INDEX NUMBER:

For Office use Only

Question No:	1	2	3	4	5	Total Marks	%	Signature
For Scrutinizer's Use Only (marks)								
For Moderator's Use Only (marks)								

- ✓ This paper has four questions.
- ✓ Answer any **three** questions.
- ✓ Questions must be answered on the question paper itself.

Question 01

a) Name the three categories of speech disorders and explain them in brief. (09 marks)

.....

.....

.....

.....

.....

.....

.....

.....

.....

.....

.....

.....

.....

.....

.....
.....
.....
.....
.....
.....
.....
.....
.....
.....
.....
.....
.....
.....
.....
.....

- b) Explain the following with an example.

 - a) Receptive language impairments
 - b) Expressive language impairments

(06 marks)

.....
.....
.....
.....
.....
.....
.....
.....
.....
.....
.....
.....
.....
.....
.....
.....
.....
.....
.....
.....
.....
.....
.....
.....
.....

.....

Question 02

a) Discuss **two** motor programming treatment approaches for patients with Developmental Verbal Dyspraxia. (06 marks)

.....

b) Discuss the common signs and symptoms of Developmental Verbal Dyspraxia in relation to

- Speech production
- Language
- Prosody

(09 marks)

.....

.....
.....
.....
.....
.....
.....
.....
.....
.....
.....
.....
.....
.....
.....
.....
.....
.....
.....
.....
.....
.....
.....
.....
.....
.....
.....
.....
.....
.....
.....
.....
.....
.....
.....
.....
.....
.....
.....
.....
.....
.....
.....
.....
.....
.....
.....
.....
.....
.....
.....
.....
.....
.....

Question 3

a) What are craniofacial anomalies?

(3 marks)

.....
.....
.....
.....
.....
.....
.....
.....
.....
.....
.....
.....
.....

b) Give a brief description of two craniofacial anomalies.

(6 marks)

.....

.....

.....

.....

.....

.....

.....

.....

.....

.....

.....

.....

.....

.....

.....

.....

.....

.....

.....

.....

.....

c) Identify and describe briefly two risk factors that increase the likelihood of cleft lip and palate.

(2 marks)

.....

.....

.....

.....

.....

.....

.....

.....

.....

.....

.....

.....

.....

.....

.....

.....

d) Write four characteristics that can be visible in the speech and language production of children affected by cleft lip and palate.

(4 marks)

.....

.....

.....

.....

.....
.....
.....
.....
.....
.....

Question 4

a) Define dysarthria.

(4 marks)

.....
.....
.....
.....
.....
.....
.....
.....
.....
.....
.....
.....
.....
.....
.....
.....
.....
.....
.....
.....
.....

b) What are the perceptual speech characteristics that are visible when the five speech sub-systems are affected? Write **one** characteristic for **each sub system**. (5 marks)

.....
.....
.....
.....
.....
.....
.....
.....
.....
.....
.....
.....
.....
.....
.....
.....
.....
.....
.....
.....
.....



CINEC Campus (Pvt) Ltd
Approved for Quality Management System

Faculty	Department / Section/Division
Management, Humanities and Social Sciences	Education and Languages

EDUCATION & TRAINING COURSE: BACHELOR OF ARTS (ENGLISH) DEGREE
COURSE CODE: LC – 0845

MID SEMESTER EXAMINATION QUESTION PAPER
YEAR 3 – SEMESTER II
ACADEMIC WRITING – ELAN 3202

INSTRUCTIONS TO CANDIDATES	
Answer all questions.	Duration of the examination = 1 ½ hours
Total marks - 20	Date: 2020.01.12
	Candidates are not allowed to communicate with and disturb fellow candidates during the examination.
	Candidates could be disqualified if you violate examination rules.

❖ **Answer all questions.**

Question 01

(10 marks)

Write a summary of the following passage in about 150 words:

Symbols convey information or embody ideas. Some are so common that we find it difficult to believe they didn't always exist. Who, for example, first used arrows to indicate directions? We follow them instinctively now, but at some point, they were new and had to be explained. Other symbols embody more complex ideas and associations. Two well-known and ancient symbols are the yin-yang symbol and the swastika.

The yin-yang symbol, also known as the *taiji diagram*, embodies the worldview expressed in ancient Chinese Philosophy. It gives elegant visual forms to ideas about the dynamic balance of opposites that are believed to make up the universe and explain existence: male (yang) and female (ying), being and non-being, light and dark, action and inaction, and so on. The symbol makes it clear that these opposites are mutually interdependent, that they are defined by each other, that both are necessary to make the whole.

The Swastika has an important lesson to teach about symbols, which is that they have no meaning in themselves but are given a meaning by a society or culture. The swastika was first used as a symbol in India and Central Asia, possibly as early as 3000 B.C.E. It takes its name from the Sanskrit word *svastika*, meaning good luck or good fortune (Sanskrit was the most important language of ancient India.) In Asia, the swastika is still widely used as an auspicious symbol, even on commercial products. Until the 1930s, Swastika was a

popular good- luck symbol in the west as well. Today, however, it is so thoroughly associated with the Nazis, who adopted it as their emblem, that it has become for us a symbol of fascism, racial hatred, and the unspeakable atrocities of the concentration camps.

Among the most pervasive symbols in our visual environment today are logos and trademarks, which are symbols of an organization or product. An impressive number of these are the work of Paul Rand, one of the most influential of all-American graphic designers. Simple, clear, distinctive, and memorable each of these cooperate logos has become familiar to millions of people around the world, instantly calling to mind the company and its products or services. As with any symbol, a logo means nothing in itself. It is up to an organization to make a logo familiar and to convince people through sound business practices to associate it with such virtues as service, quality, and dependability.

Question 02

(10 marks)

Paraphrase the following texts.

Text 1

If you look at two different languages you often find similarities between them in addition to the numerous differences. Why might this be the case? As it turns out there are a number of reasons for two languages to have certain elements in common. One reason is so basic that it seems rather obvious languages are spoken by humans and humans are anatomically similar. So the fact that lots of languages around the world make use of many of the same sounds in their phonological inventories is at least in part due to the similarity of the apparatus we all use to make those sounds (Wilson & Mihaliček, 2011).

Text 2

A lot of English language learners have low proficiency in EFL vocabulary classes. Therefore, it is important for teachers to utilize more effective vocabulary teaching methods to improve EFL learners' vocabulary. In this concern, using the flipped classroom method may play an important role in developing Saudi female university students' performance on EFL vocabulary classes. (Alnuhayt, 2018).

..... *END OF THE QUESTION PAPER*



CINEC Campus (Pvt) Ltd
Approved for Quality Management System

Faculty	Department / Section/Division
Management, Humanities and Social Sciences	Education and Languages

EDUCATION & TRAINING COURSE: BACHELOR OF ARTS (ENGLISH) DEGREE

COURSE CODE: LC – 0845

MID SEMESTER EXAMINATION QUESTION PAPER

YEAR 3 – SEMESTER II

WORLD LITERATURE IN TRANSLATION – ELIT 3201

INSTRUCTIONS TO CANDIDATES

Duration of the examination = 1 ½ hours

Date: 2020.01.11

Candidates are not allowed to communicate with and disturb fellow candidates during the examination.

Candidates could be disqualified if you violate examination rules.

This paper has three sections and five questions.

Answer three questions selecting one from each section.

Each question carries 20 marks.

SECTION A

QUESTION 1 (Compulsory)

The portrayal of female characters in *Mother* by Maxim Gorky and *Mother Courage and Her Children* by Bertolt Brecht is unconventional. Do you agree?

SECTION B

QUESTION 2

Evaluate the role of Pavel as a revolutionary hero in Maxim Gorky's *Mother*.

OR

QUESTION 3

Describe how the conflict between the rich and poor is portrayed in *Mother* by Maxim Gorky.

SECTION C

QUESTION 4

“*The Uprooted* by Martin Wickramasinghe deals with a transitional period in which the feudal society decays and the capitalistic society rises.” Comment.

OR

QUESTION 5

The issue of romance is not a secondary theme in *The Uprooted* by Martin Wickramasinghe.
Do you agree?

..... *END OF THE QUESTION PAPER*



CINEC Campus (Pvt) Ltd
Approved for Quality Management System

Faculty Management, Humanities and Social Sciences	Department / Section/Division Education and Languages
EDUCATION & TRAINING COURSE: BACHELOR OF ARTS (ENGLISH) DEGREE COURSE CODE: LC - 0845	
MID SEMESTER EXAMINATION QUESTION PAPER YEAR 3 - SEMESTER II PSYCHOLINGUISTICS - ELAN 3203	
INSTRUCTIONS TO CANDIDATES	
There are five (05) questions in this paper.	Duration of the examination = 1 ½ hours
Candidates are required to answer any three (03) Questions.	Date: 2020.01.11
Each question carries 20 marks.	Candidates are not allowed to communicate with and disturb fellow candidates during the examination.
	Candidates could be disqualified if you violate examination rules.

THERE ARE FIVE (05) QUESTIONS IN THIS PAPER.
ANSWER ANY THREE (03) QUESTIONS.

QUESTION 01

(20 marks)

Discuss the importance of the following areas of the brain in speech production.

- Broca's Area (10 marks)
- Wernicke's Area (10 marks)

QUESTION 02

(20 marks)

Providing an illustration, examine how Wernicke-Geschwind model describes the brain activity when we speak a heard word.

QUESTION 03

(20 marks)

Brain Lateralization theory stresses on the fact that the two halves of the brain known as right and left hemispheres function differently but yet interdependently. Discuss.

QUESTION 04

(20 marks)

Humans and chimpanzees share an indelible bond which most strikingly manifest through our genetic similarity (Wildman *et al.* 2003). Nonetheless, the uniqueness of human speech and language remains a remarkable discontinuity between the two species (e.g. Chomsky 1980; Pinker & Jackendoff 2005). Analyze the psycholinguistic differences between humans and chimpanzees.

QUESTION 05

(20 marks)

The continued study of Infant Speech Perception promises to reveal the precise nature of the relationship between language acquisition and the brain. Comment.

..... *END OF THE QUESTION PAPER*



Faculty of Science and Engineering

EXAMINATION PAPER

Module Code	4MA007
Module Title	Engineering Mathematics
Date of Examination:	February 2020
Examiner:	Ms.B.S Wijerathne
Examiner(s) Room:	06
Time Allowed:	3 Hours
Number of Questions to be attempted:	Attempt ALL questions
Marks awarded for each question are stated at the end of each question	

Materials Required:

One eight-page answer book.

Additional information is provided on page 4.

Instructions to Students:

- Mobile phones are not permitted in the exam.
- Approved calculator only.
- You should write legibly in black or blue ink.
- Check your work carefully for inaccurate spelling, punctuation and grammar.
- You may not leave the examination room during the first hour or last 30 minutes of the exam.
- An announcement will be made when there are 30 minutes of the exam time left

- A1. Solve the following system of equations **using any method involving matrices**. (You should show all the steps in your calculations)

$$2x + 3y - z = -2$$

$$x + y + 2z = 12$$

$$3x - 4y + 4z = 33$$

(10 marks)

- A2. The instantaneous voltage v in a capacitive circuit is related to time t by the equation $v = Ve^{-t/CR}$ where V , C and R are constants. Determine v , correct to 4 significant figures, when $t = 45\text{ms}$, $C = 15\mu\text{F}$, $R = 50\text{k}$ and $V = 320$ volts.

(5 marks)

- A3. An alternating voltage of 240V , 50Hz is connected across an impedance of $(60 - j 100)\Omega$. Determine the resistance and the capacitance.

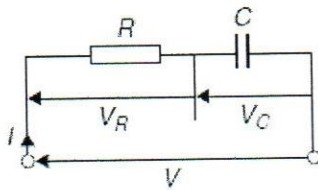

Figure 1

(10 marks)

- A4. Find the magnitude of the forces acting upon joints 1, 2 and 3 (J_1 , J_2 and J_3) for the following system (figure 2 on page 3)

- By resolving forces into vertical and horizontal components
- Without resolving the forces (using the force diagram)

Find the answers correct to 2 decimal places

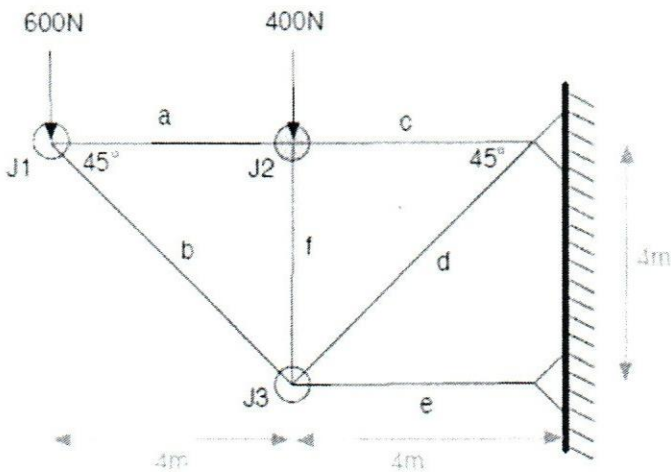

Figure 2

(30 marks)

A5. a) Determine the coordinates of the maximum and minimum values of the following graph.

$$y = \frac{x^3}{3} - \frac{x^2}{2} - 6x + \frac{5}{3}$$

b) Sketch the graph showing maximum and minimum points that you have found

(15 marks)

A6. Solve the following first order differential equations.

i) $(xy + y) \frac{dy}{dx} = xy + x$

ii) $3 \frac{dy}{dx} + 5x = 4$

iii) $\frac{dy}{dx} = \frac{\cos(x)}{\sin(y)}$

iv) $\frac{dy}{dx} = x^2 \sin(x)$

(15 marks)

A7. A pot is baked in an oven at a temperature of 400°C into a workshop that is constantly at a temperature of 32°C. After one hour the temperature of the pot is 175°C. Assume Newton's law of cooling.

- i) What will be the temperature of the pot after 150 minutes?
 ii) How long will it take until the pot cools to 100°C

(15 marks)

END OF THE EXAMINATION

Additional Information

I. Inverse of a matrix

For matrix A, $A^{-1} = \frac{\text{adj}(A)}{|A|}$

II. Standard Derivatives

$f(x)$	$f'(x)$
x^n	nx^{n-1}
$\sin ax$	$a \cos ax$
$\cos ax$	$-a \sin ax$
e^{ax}	ae^{ax}

III. Standard Integrals

$f(x)$	$\int f(x)dx$
x^n	$\frac{x^{n+1}}{n+1}$, for $x \neq -1$
e^x	e^x
e^{ax}	$\frac{1}{a} e^{ax}$
$\frac{1}{x}$	$\ln x$
$\sin ax$	$-\frac{1}{a} \cos ax$
$\cos ax$	$\frac{1}{a} \sin ax$

IV.

Rules of differentiation	$\frac{d}{dx}(uv) = u \frac{dv}{dx} + v \frac{du}{dx}$ $\frac{d}{dx} \left(\frac{u}{v} \right) = \frac{v \frac{du}{dx} - u \frac{dv}{dx}}{v^2}$ $\frac{dy}{dx} = \frac{dy}{du} \frac{du}{dx}$
Integration by parts equation	$\int u \frac{dv}{dx} dx = uv - \int v \frac{du}{dx} dx$

V.

$$Z = R + jX ,$$

Where,

$Z = \text{Impedence}$

$R = \text{Resistance}$

$X = \text{Reactance}$

$$X = X_L - X_C$$

Where,

$X_L(\text{inductive reactance}) = 2\pi fL \text{ ohms}$

$X_C(\text{capacitive reactance}) = \frac{1}{2\pi fC} \text{ ohms}$

where, $f = \text{frequency}$

$L = \text{inductance}$

$C = \text{capacitance}$

VI. **Newton's law of cooling**

Newton's law of cooling states that the rate of change of temperature is proportional to the difference of temperature between the body and its environment